

**stûv**<sub>21</sub>

---

Fire, both open and closed

21

**Stûv Stories +Stûv 21**

A pure mix  
of an open and  
closed fire

[stuv.com](https://stuv.com)

## Stûv Stories

Welcome to the world of Stûv! Our products provide ways to layout and rearrange your interior. The story that they tell is straightforward and warm, simple and efficient. A story where appearance is functional and where objects blend into the architecture. Quality and perfection are the watchwords at Stûv. To improve is to simplify. This means humanising design. It also means constant innovation until a perfect harmony is found between pleasure and respect for the environment. Stûv is a state of mind.







Stûv Stories +Stûv 21

# Stûv, the creator of the retractable glass door



Stûv Stories +Stûv 21-family

A family of products  
both open and closed





The Stûv 21 range is a typical family. Sober and discrete, with a focus on the purity and beauty of the fire. However, it is also an open family full of warmth and fun. A fire which is open and closed at the same time thanks to the window which can be opened partially or fully. The Stûv 21 is available in a single-face or double-face model and in a number of different sizes. The frames, front panel and casing complement the fire to ensure a perfect finish and enhancement. The Stûv 21 family, the unique combination of optimum performance and atmosphere.











the perfect  
marriage between  
**sobriety**  
and atmosphere



**Stûv Stories**



The valve allows one to regulate the volume of air entering the apparatus and therefore the amount of heat released.

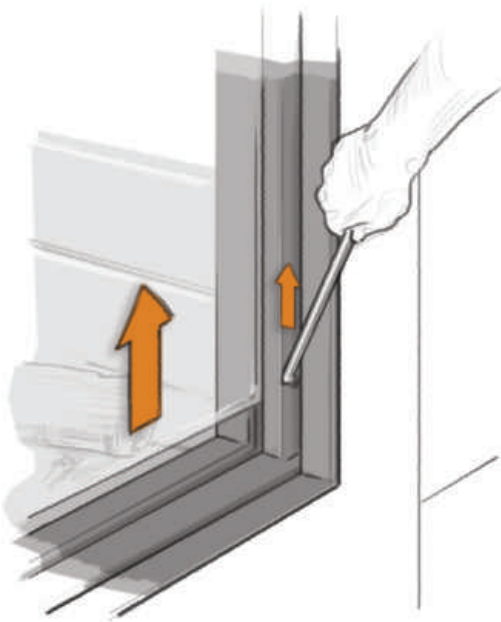
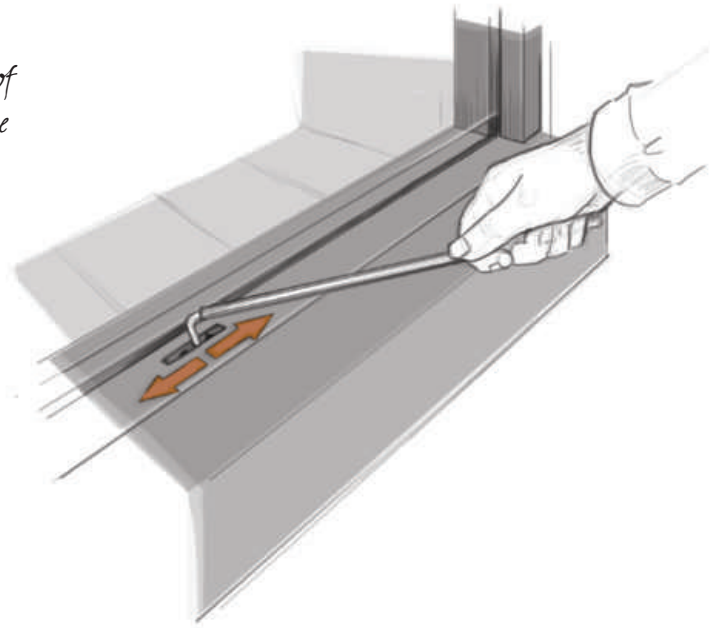

The glass door of the Stiv 21 slides into the frame and can be fully retracted behind the front panel.

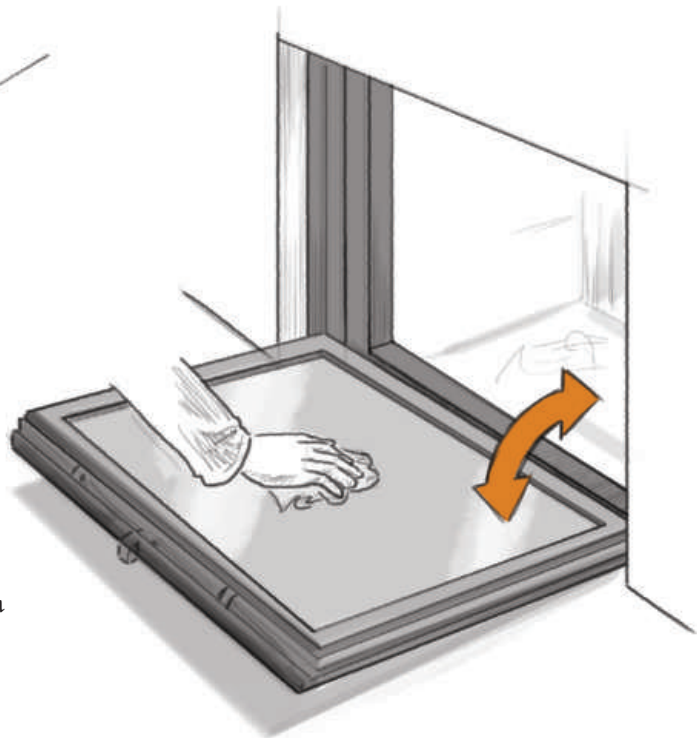

In order to facilitate the cleaning and maintenance of the window, the frame can be tipped without having to dismantle it.





Stûv Stories +Stûv 21

By professionals,  
for fire lovers

## Stûv Stories +Stûv 21-65-C

- + Heat output regulation
- + Ability to be connected to the outside air
- + Air-funnelling option
- + Fan option



# Choose a suitable frame

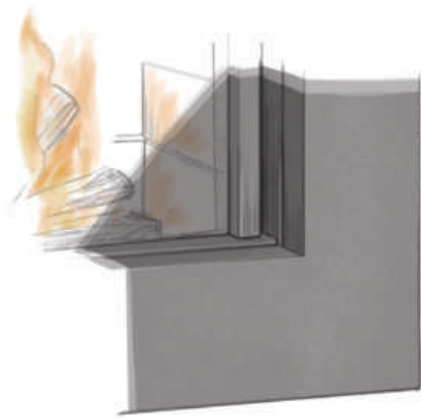

*Stuv SF4: large frame available in many different colours. Also available in customised sizes.*

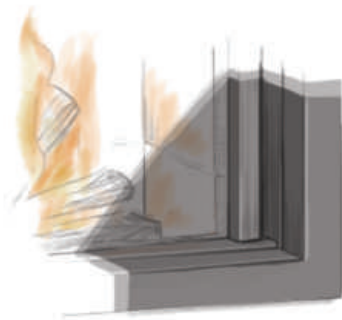

*Narrow frame in StuvGrey steel*

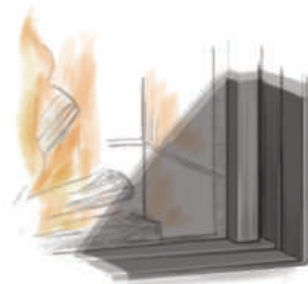

*Thin frame in 4mm StuvGrey steel*





model shown: Stûv 21-65H with frame SF6 RAL 9010

## Stûv Stories +Stûv 21-65-H

- + Heat output regulation
- + Ability to be connected to the outside air
- + Air-funnelling option
- + Fan option

## Stûv Stories +Ready-to-fit SF15 fireplace



- + Steel chimney integrating air convection inlets and outlets – no need for decorative grilles
- + Easy installation
- + The front panel can open to allow maintenance or access to regulation elements.



model shown: Stûv 21-75 with thin frame 4mm



## Stûv Stories +Stûv 21-75

- + Heat output regulation
- + Ability to be connected to the outside air
- + Air-funnelling option
- + Fan option

Enjoy your fire the  
way you want it

## Stûv Stories +Stûv 21-85

- + Heat output regulation
- + Ability to be connected to the outside air
- + Air-funnelling option
- + Fan option
- + Available in two interior shades: light or dark



A stylish fire...

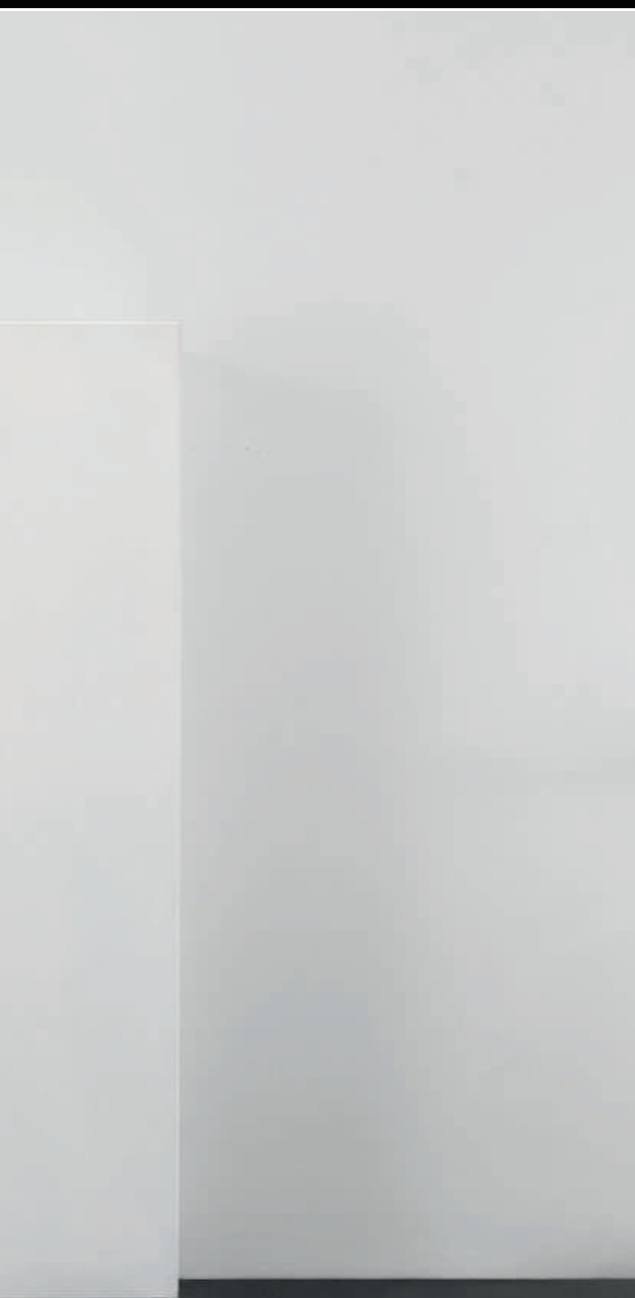

model shown: Stûv 21-85 light interior with façade SF2 RAL 9010

Sober, it blends  
perfectly into any interior





## Stûv Stories +Stûv 21-95

- + Heat output regulation
- + Ability to be connected to the outside air
- + Air-funnelling option
- + Fan option



## Stûv Stories +Stûv 21-105

- + Heat output regulation
- + Ability to be connected to the outside air
- + Air-funnelling option
- + Fan option
- + Available in two interior shades: light or dark

Integration of fire into  
the architecture





## Stûv Stories +Stûv 21-105 SF8



- + Steel frame finish with lateral extensions
- + Perfect harmony with the fire
- + Available made-to-measure



## Stûv Stories +Stûv 21-125

- + Heat output regulation
- + Air-funnelling option
- + Fan option





## Stûv Stories +Stûv 21-135

- + Heat output regulation
- + Air-funnelling option
- + Fan option



Finish shown: Stûv 21-135 with frame SF4 RAL 9010

## Stûv Stories +Stûv 21-75DF

- + Heat output regulation
- + Ability to be connected to the outside air
- + Air-funnelling option
- + Fan option



## Stûv Stories +Stûv 21-85DF

- + Heat output regulation
- + Ability to be connected to the outside air
- + Air-funnelling option
- + Fan option



Double face:  
glass door retractable  
on both sides

## Stûv Stories +Stûv 21-95DF

- + Double face: glass door retractable on both sides
- + Heat output regulation
- + Ability to be connected to the outside air
- + Air-funnelling option
- + Fan option





## Stûv Stories +Stûv 21-125DF

- + Double face: glass door retractable on both sides
- + Heat output regulation
- + Ability to be connected to the outside air
- + Air-funnelling option
- + Fan option



## Stûv Stories +Facades

- + Subtle colours, designed in collaboration with colourist Bernard Gilbert
- + Perfect harmony with the fire
- + Colours give different tones during the course of the day

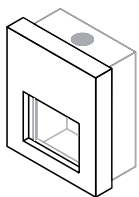

SF1

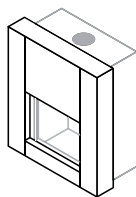

SF1 AIR\*

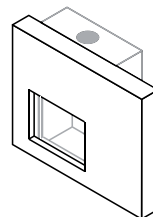

SF2

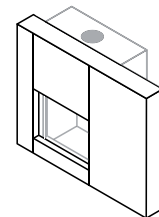

SF2 AIR\*

\* the AIR models are compatible with the external air connection

# Front panels in wonderful colours

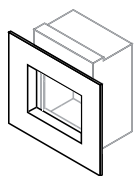

SF4

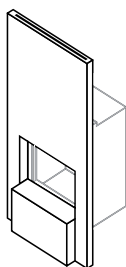

SF5

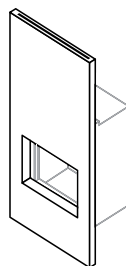

SF6

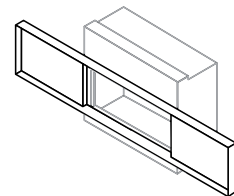

SF8

## Stûv Stories +Ready-to-fit fireplaces

+ Available in a selection of 19 colours

+ Also available in rust

+ Direct inlet of exterior air



SF2 rust



SF2 AIR RAL 9010

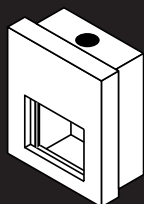

SF1

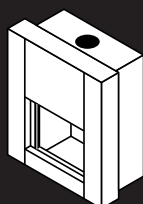

SF1 AIR\*

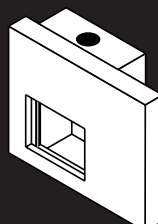

SF2

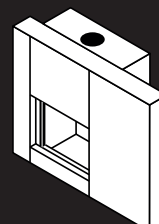

SF2 AIR\*

\* the AIR models are compatible with the external air connection



# Front panels to suit the tastes of all generations!



SF15

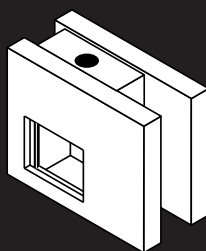

DF2

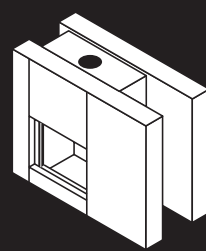

DF2 AIR\*

Stûv Stories +Stûv 21

Wonderfully  
purified design



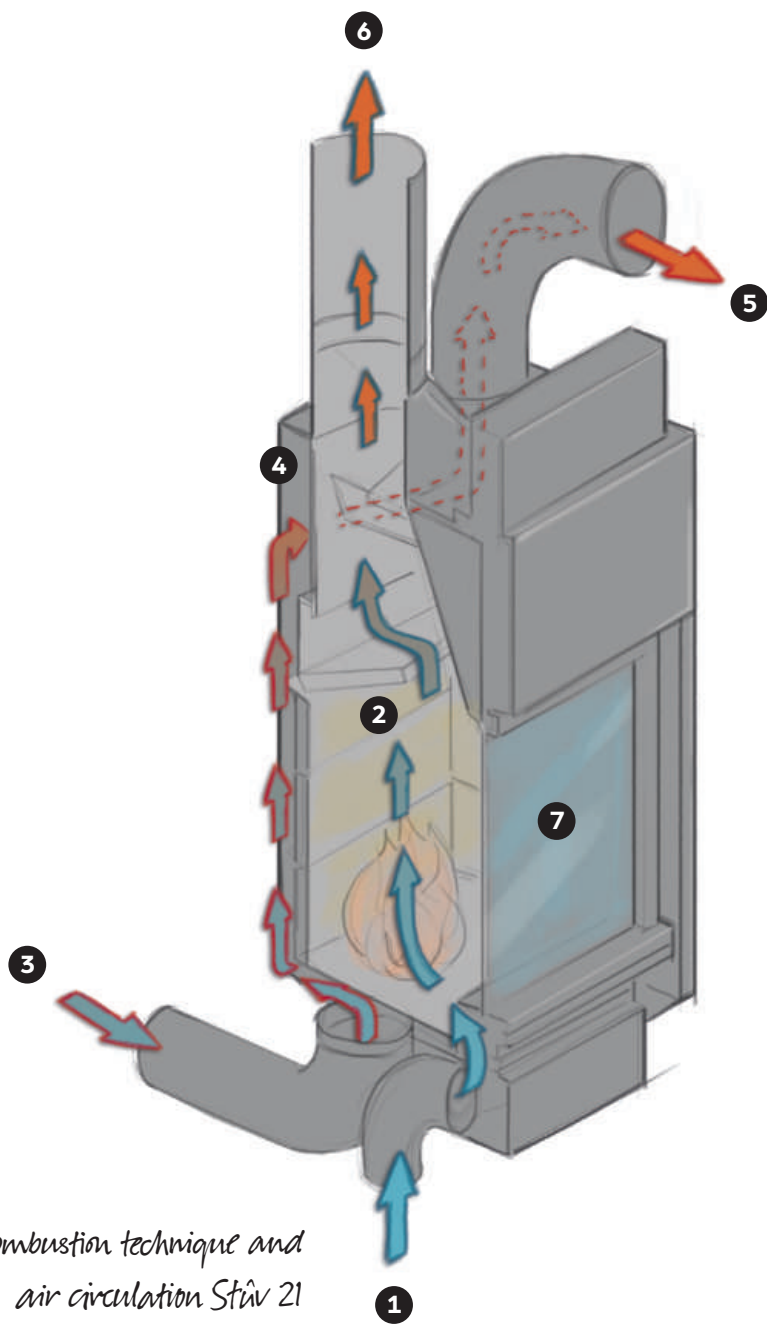

*Combustion technique and air circulation Stûv 21*

- 1 Combustion air.  
Illustration with direct air intake under the stove. The outside air intake can also be located at the rear of the stove.
- 2 Combustion.  
The air intake, the combustion chamber and smoke exhaust form an airtight system.
- 3 The air is taken into the room then heated by the stove.
- 4 The hot air is exchanged with the convection air which flows along the combustion chamber.
- 5 Heated air is spread throughout the room thanks to natural convection.
- 6 Burnt gases are released via the flue. Illustration with vertical discharge.
- 7 The window cleaning system involves an air supply that takes flue gasses away from the glass. This means that you can have flickering flames at all times.



## Stûv Stories +Stûv mobilobox and log trolley



- + Mobilobox: everything is to hand (matches, maintenance products, barbecue kit, kindling etc.)
- + User-friendly log trolley, with simple and sleek lines: an essential accessory for all Stûv stoves.

## Stûv Stories +Stûv barbecue

Would you like to feel like you do in the summer all the year round? Now it's possible! Cooking food is healthier with the Stûv barbecue, as it is placed in front of the flames and not above the embers. Kebabs, sausages or fish is cooked in this way by radiation and not likely to get burnt by the drops of grease which flare up when they come in contact with burning charcoal. Installing the grill on the stove is child's play and, so that nothing spoils your pleasure, the chimney draught sucks away all the smells!



# Stûv 21

## technical specifications



technical specifications	Stûv 21/65 C	Stûv 21/65 H	Stûv 21/75 SF	Stûv 21/85 SF	Stûv 21/95 SF
weight   kg	155	197	182	234	292
nominal heat power   kW	7	12	10	13	15
optimum output range   kW	5-12	8-12	8-11	8-14	10-18
efficiency   %	76	78	80	78	76
CO emissions  %	0,08	0,06	0,07	0,08	0,09
particle emissions*   mg/Nm <sup>3</sup>	65	13	16	22	18
range of wood consumption**   kg/h	1,5-3,5	2,3-3,7	2,2-3,1	2,3-4,0	2,9-5,3
length of logs   V / H - cm	33/33	33/50	50/50	50/50	60/50
outside air intake   ø mm	100	100	100	100	100
patent	1445541	1445541	1445541	1445541	1445541

Options	Stûv 21/65 C	Stûv 21/65 H	Stûv 21/75 SF	Stûv 21/85 SF	Stûv 21/95 SF
+ open fire possible	s	s	s	s	s
+ barbecue kit	o	o	o	o	o
+ outside air connection	o	o	o	o	o
+ electric ventilation	o	o	o	o	o

Dimensions	21/65-C SF	21/65-H SF	21/75 SF	21/85 SF	21/95 SF
+ (A) width   mm	650	650	750	850	950
+ (B) depth   mm	440	490	490	540	590
+ (C1) max. height   mm	1165	1455	1137	1295	1455
+ (C2) min. height   mm	1010	1225	1005	1115	1225
+ (D) width of the glass   mm	470	470	570	670	770
+ (E) height of the glass   mm	470	615	456	535	615
+ (F) width of the opening   mm	584	584	684	784	884
+ (G) height of opening   mm	539	683	524	603	683
+ (H) duct diameter - Ø   mm	180	200	180	200	250
+ (I) position of the duct   mm	171	196	186	201	221

\* measurement method in accordance with DIN +

\*\* at 12 % humidity

V/H vertical position/horizontal position

o optional

s standard

- not available





Stûv 21/105 SF	Stûv 21/125 SF	Stûv 21/135 SF	Stûv 21/75 DF	Stûv 21/85 DF	Stûv 21/95 DF	Stûv 21/125 DF
224	305		187	236	297	310
19	21	20	19	22	22	27
7-19	11-23	11-21	9-19	11-21	12-27	14-27
84	76	76	75	75	76	72
0,09	0,10	0,08	0,08	0,06	0,05	0,21
15	22	64	30	15	31	31
1,9-5,1	3,2-6,6	3,2-6,2	2,8-6,1	3,3-6,3	3,6-8,0	4,3-8,3
33/80	50/100	50/100	-/50	-/50	-/50	-/100
100	-	-	100	100	100	-
1445541	1445541	1445541	1445541	1445541	1445541	1445541

Stûv 21/105 SF	Stûv 21/125 SF	Stûv 21/135 SF	Stûv 21/75 DF	Stûv 21/85 DF	Stûv 21/95 DF	Stûv 21/125 DF
s	s	s	s	s	s	s
o	o	o	o	o	o	o
o	-	-	o	o	o	-
o	o	o	o	o	o	o

21/105 SF	21/125 SF	21/135 SF	21/75 DF	21/85 DF	21/95 DF	21/125 DF
1050	1250	1350	750	850	950	1250
496	563	500	670	670	670	670
1040	1295	1040	1136	1295	1455	1295
-	1115	-	1005	1115	1225	1115
870	1070	1170	570	670	770	1070
400	535	400	456	535	615	535
984	1184	1282	684	784	884	1184
469	603	469	524	603	683	603
200	300	250	250	250	250	300
201	221	203	336	336	336	336

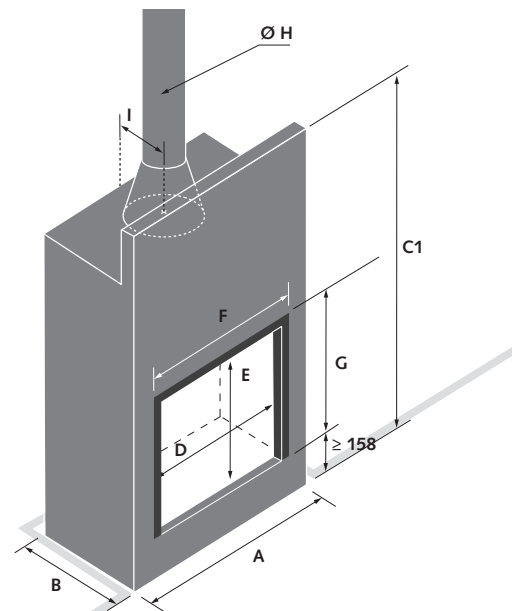
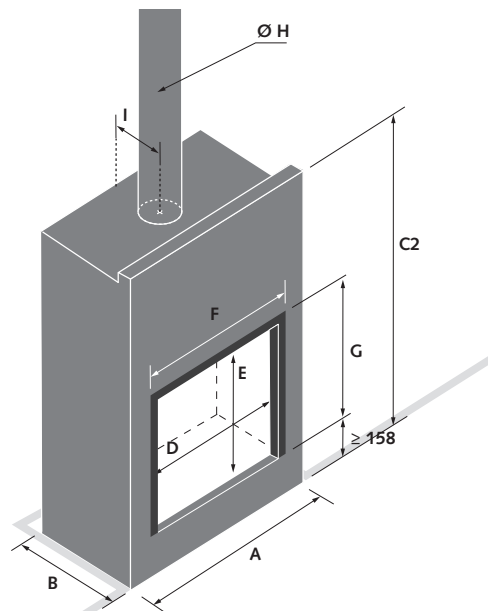

## Stûv 21 Facades

		SF1	SF1 AIR	SF2	SF2 AIR	SF4	SF5	SF6	SF8
<b>21/65H</b>	H	-	-	-	-	1164	-	2010	-
	L	-	-	-	-	1064	-	884	-
	E	-	-	-	-	24	-	70	-
<b>21/75</b>	H	1270	1430	1270	1430	1004	2010	2010	-
	L	1084	1084	1584	1584	1164	984	984	-
	E	200	200	200	200	24	170	70	-
<b>21/85</b>	H	1370	1530	1370	1530	1084	2000	2000	-
	L	1184	1184	1684	1684	1264	1084	1084	-
	E	200	200	200	200	24	170	70	-
<b>21/95</b>	H	1490	1650	1490	1650	1163	2000	2000	-
	L	1284	1284	1784	1784	1364	1184	184	-
	E	200	200	200	200	24	170	70	-
<b>21/105</b>	H	-	-	1164	1325	949	2000	-	481
	L	-	-	1884	1884	1464	1284	-	2400
	E	-	-	200	200	24	170	-	100
<b>21/125</b>	H	1370	-	1370	-	1084	2000	2000	-
	L	1584	-	2084	-	1664	1484	1484	-
	E	200	-	200	-	24	170	70	-
<b>21/135</b>	H	-	-	-	-	918	-	-	-
	L	-	-	-	-	1724	-	-	-
	E	-	-	-	-	24	-	-	-

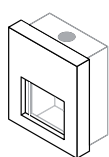

SF1

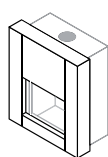

SF1 AIR

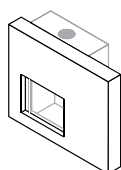

SF2

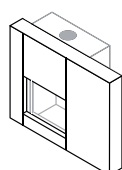

SF2 AIR

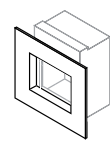

SF4

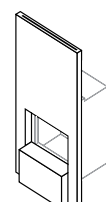

SF5

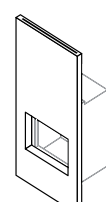

SF6

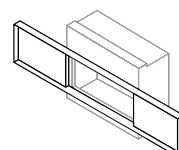

SF8

## Stûv 21 Ready-to-fit fireplaces

		SF1	SF1 AIR	SF2	SF2 AIR	SF15	DF2	DF2 AIR
<b>21/65H</b>	H	-	-	-	-	1977	-	-
	L	-	-	-	-	776	-	-
	P	-	-	-	-	533	-	-
<b>21/75</b>	H	1270	1430	1270	1430	-	1270	1430
	L	1084	1084	1584	1584	-	584	1584
	P	570	570	570	570	-	800	800
<b>21/85</b>	H	1370	1530	1370	1530	-	1370	1530
	L	1184	1184	1684	1684	-	1684	1685
	P	620	620	620	620	-	800	800
<b>21/95</b>	H	1490	1650	1490	1650	-	1490	1650
	L	1284	1284	1784	1784	-	1784	1784
	P	670	670	670	670	-	800	800
<b>21/105</b>	H	-	-	1164	1325	-	-	-
	L	-	-	1884	1884	-	-	-
	P	-	-	570	570	-	-	-
<b>21/125</b>	H	1370	-	1370	-	-	1370	-
	L	1584	-	2084	-	-	2084	-
	P	640	-	640	-	-	800	-

H height (mm)  
 L width (mm)  
 P depth (mm)  
 E thickness visible from the front (mm)

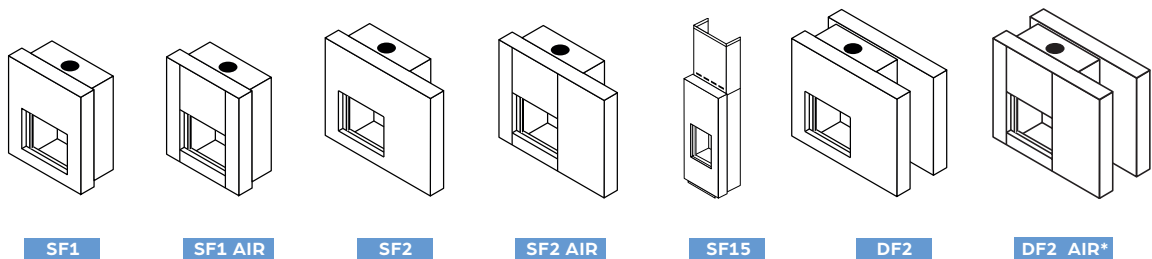



## The constant search for improvement...

Stûv invests enormously in research and development in both its own laboratory and thanks to its partnerships with specialists in the field of combustion. Each detail is important in optimising the performance of the stove. Stûv devices meet the most stringent standards in terms of respect for the environment. We give priority to ergonomics and simplicity at all stages – installation, use, maintenance – so that every user can use their Stûv exactly how they want it. This is the reason we provide detailed installation instructions, we select our sales network and organise training sessions for our retail and installation partners.

### The Stûv guarantee

- + Stûv fires are renowned for their design and performance. They are also solid, reliable and durable.
- + The fires and their components are made in Europe with the utmost care. A well-maintained Stûv fire is for life.
- + This is why Stûv offers the users of its products an extended guarantee. Three years' guarantee in addition to the legal guarantee.
- + In total, 5 years on the body of the fire, 3 years on the electrical components and 3 years on the other components.

### What do you need to do to benefit from this extended guarantee?

Complete the guarantee form that you will find at the end of the user manual and return the hard copy to Stûv or – the easier option – complete the online form at [stuv.com](http://stuv.com).



All Stûv fires are designed to burn wood with a humidity level of less than 20 %.

All Stûv fires were tested according to EN 13240 CE and EN 13229.

Complies with standards :

Stûv 21/65 C, 21/125 SF : Flamme Verte 5\* (FR), BlmSchV 1 (DE), LRV (CH), DIN+ (EU), BE Phase 1 & 2 (BE), VKF (CH)

Stûv 21/65 H, 61/75 SF & DF, 21/85 SF & DF, 21/95 SF & DF, 21/105 SF : Flamme Verte 7\*(FR), BlmSchV 1 & 2 (DE),

LRV (CH), DIN+ (EU), BE Phase 1, 2 & 3 (BE), VKF (CH)

Stûv 125 DF : Flamme Verte 4\* (FR), DIN+ (EU), VKF (CH)

Stûv 21/135 SF : Flamme Verte 5\* (FR), BlmSchV 1 (DE), LRV (CH), DIN+ (EU), AEAI (CH)

## Colophon

design Brigitte Boits

styling Edith Vervest

copy JP Nieuwerkerk

communication manager Serge Alhadeff

responsible editor Gérard Pitance

Documents and photos are for information purposes only. Stûv reserves the right to make changes without warning. Every care has been taken in the preparation of this brochure; however, we do not accept any responsibility for any mistakes that it may contain.

photos: pp. 16, 24 ©Atelier Blink & Jacky Lecouturier,  
pp.11, 32-36 : © François Chevalier; pp. 28, 31 © Laurent Brandajs;  
p. 29 © Jean-Yves Clément;  
p. 22 : © William Reue; pp.5, 24 © Luc Roymans; p. 27 © O. Szczepaniak;  
p. 27 © Olivier samso, Arcand/Osa images;  
pp. 12, 14, 15, 18, 23, 25, 30, 32, 34, 37, 43 © Olivier Vandentempel

## **Stûv 16**

Pure simplicity

## **Stûv 21**

+ Fire, both open and closed

## **Stûv 30**

Subtle curves, endless possibilities

## **Stûv 30-compact**

Subtle curves, pure heat

## **Stûv microMega**

micro volume inside,  
Mega view of the flames

Stûv stoves are distributed by :

---

---

Stûv stoves are designed and  
manufactured by: **Stûv nv**  
rue Jules Borbouse 4  
B - 5170 Bois - de - Villers  
Belgium  
t +32 (0)81 43 47 96  
info@stuv.com  
**stuv.com**

Join us on :



**stûv**